

# Softub®

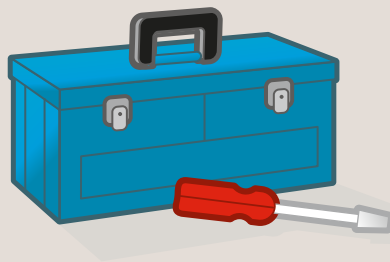

[www.softub.sk](http://www.softub.sk)

# Softub®

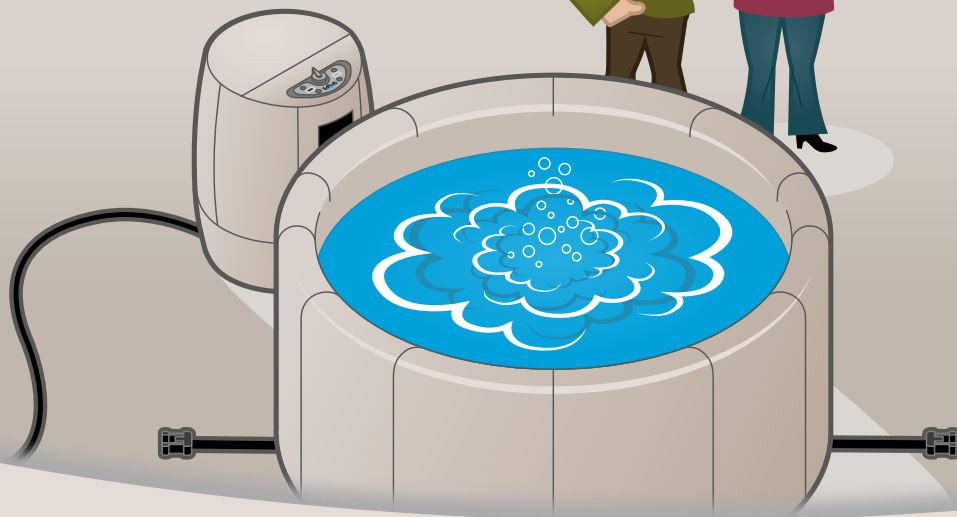
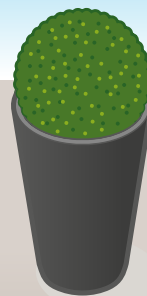
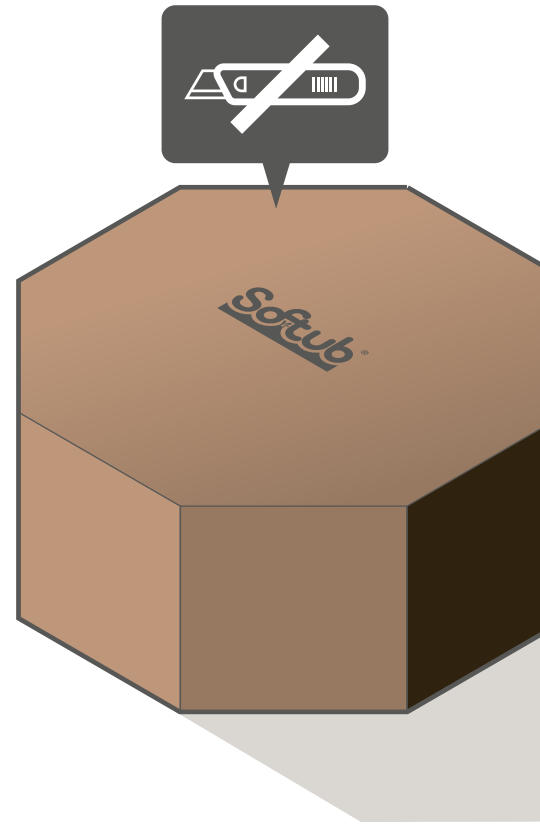
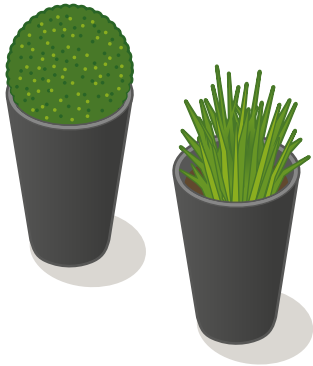

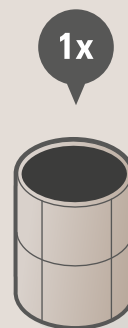
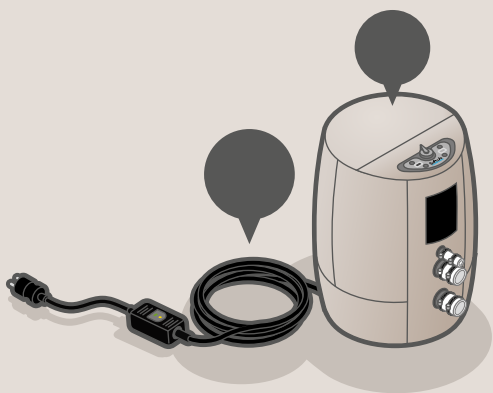
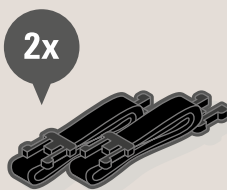
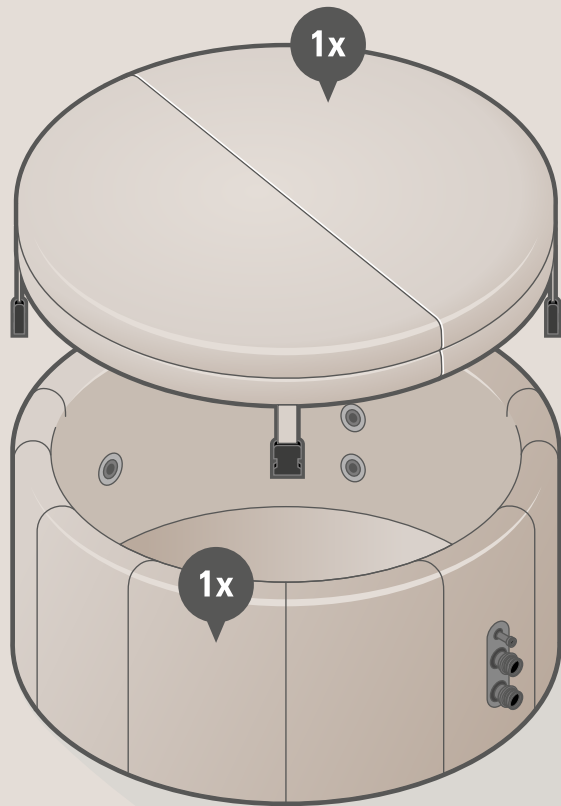

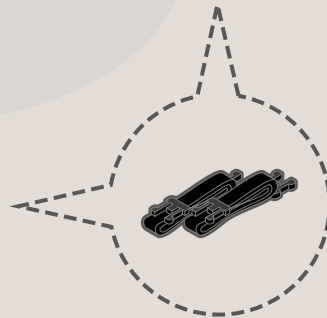
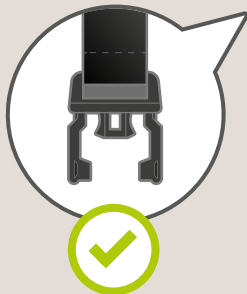
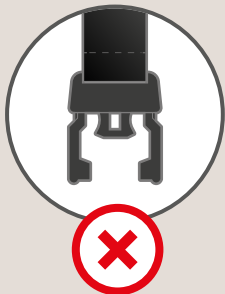
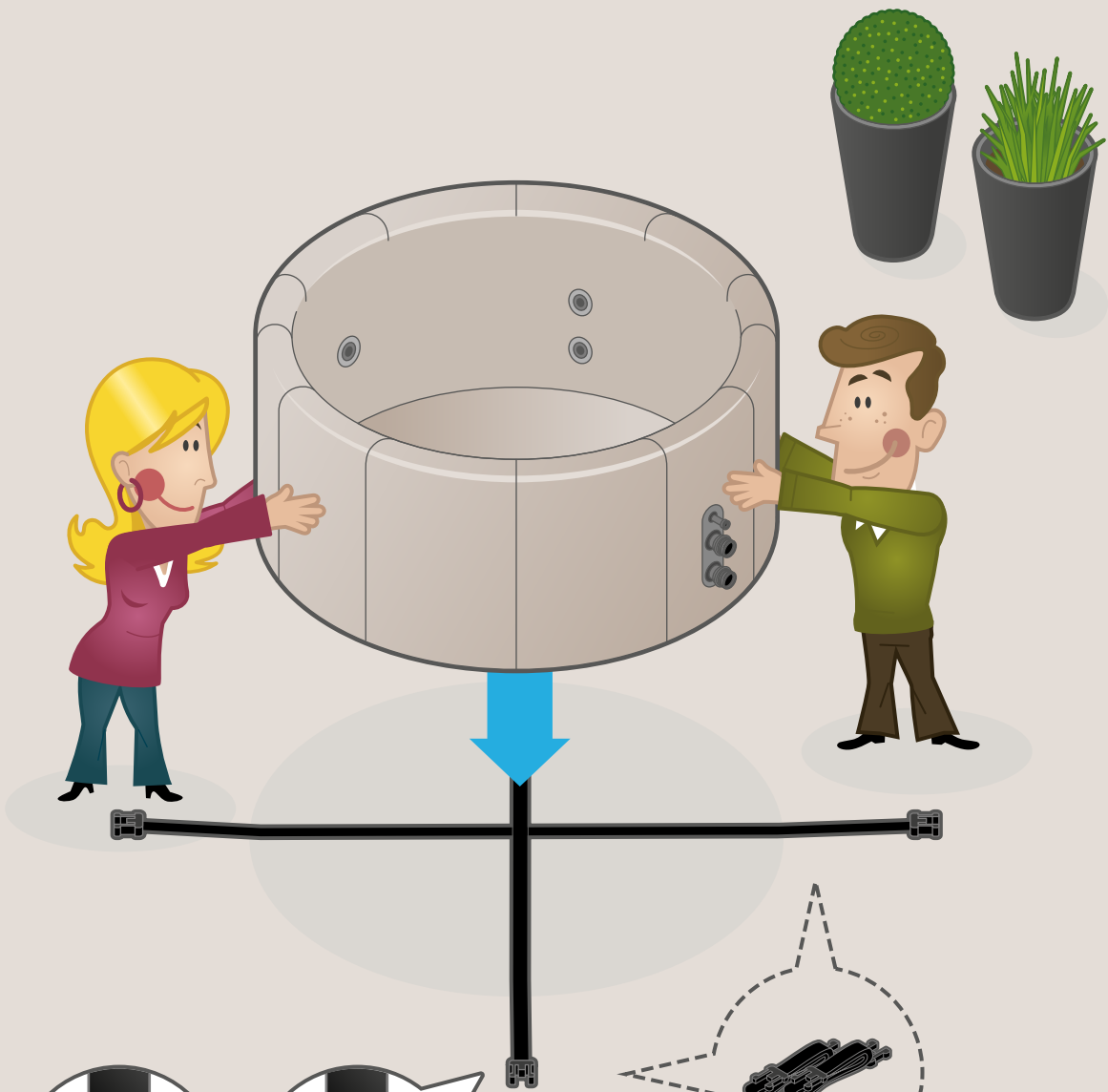

2

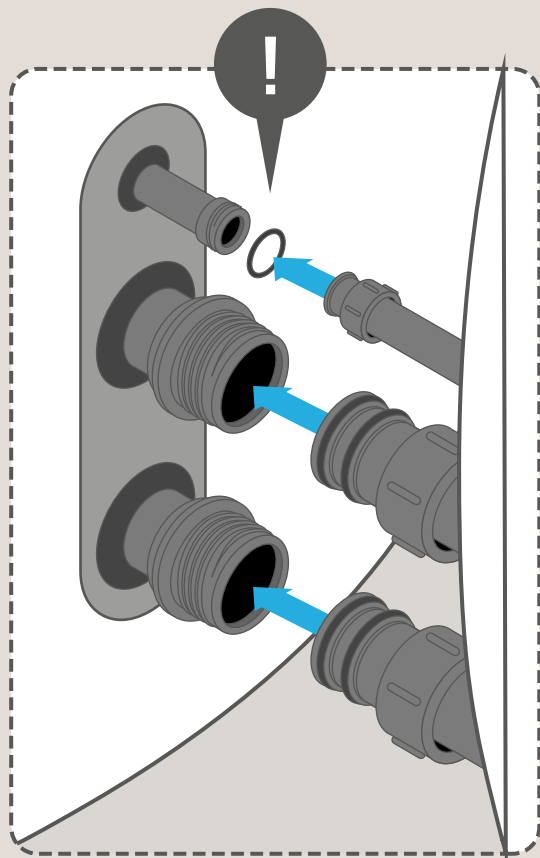

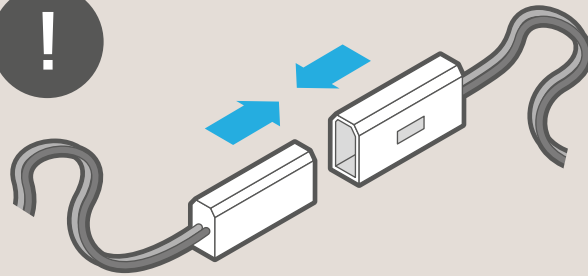
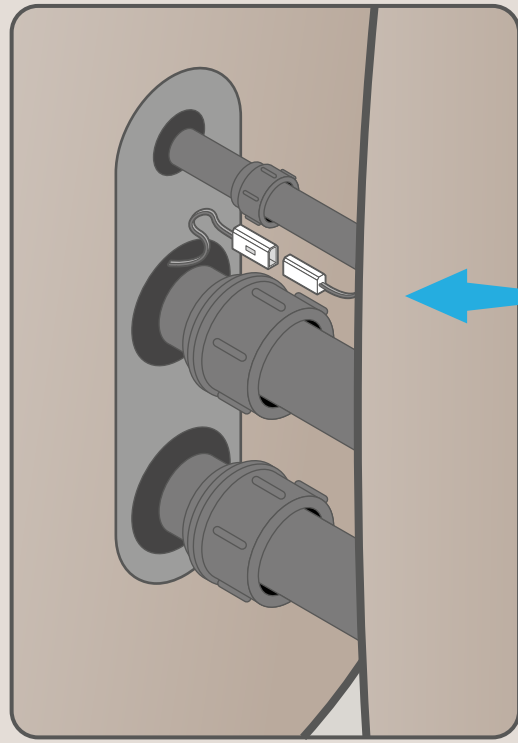
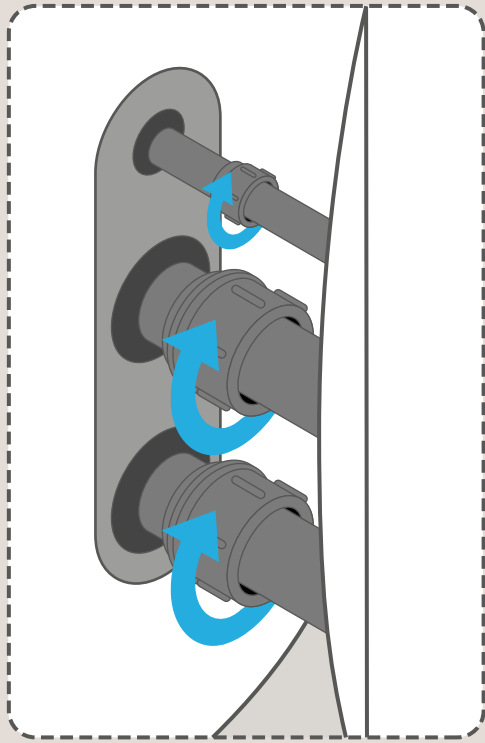

4

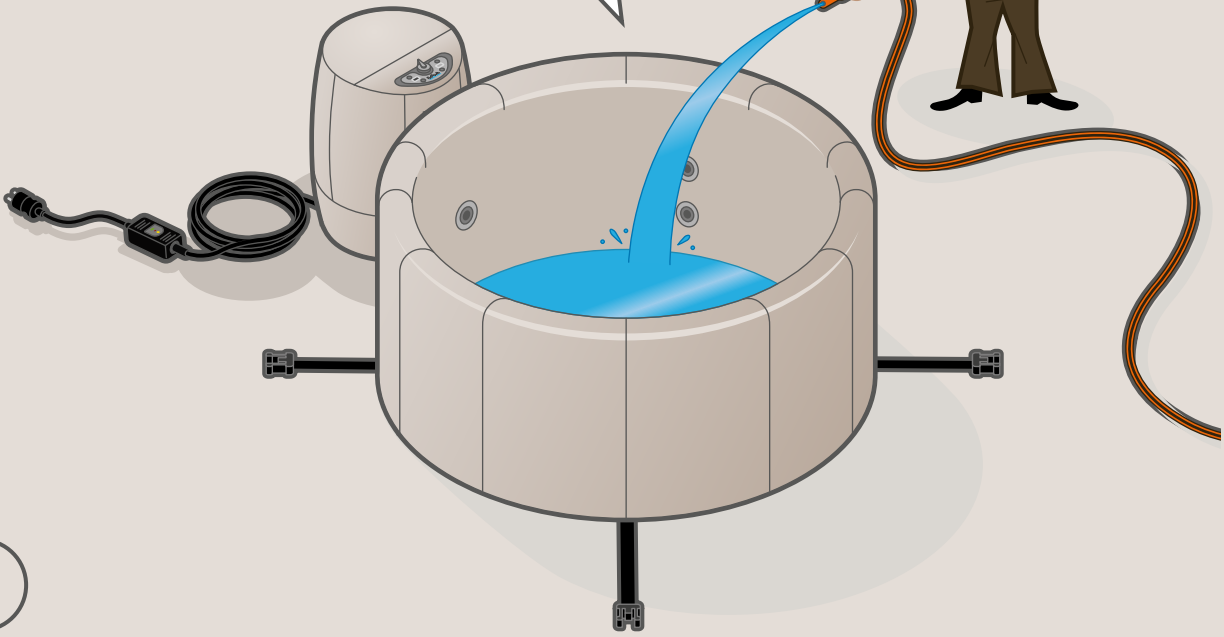
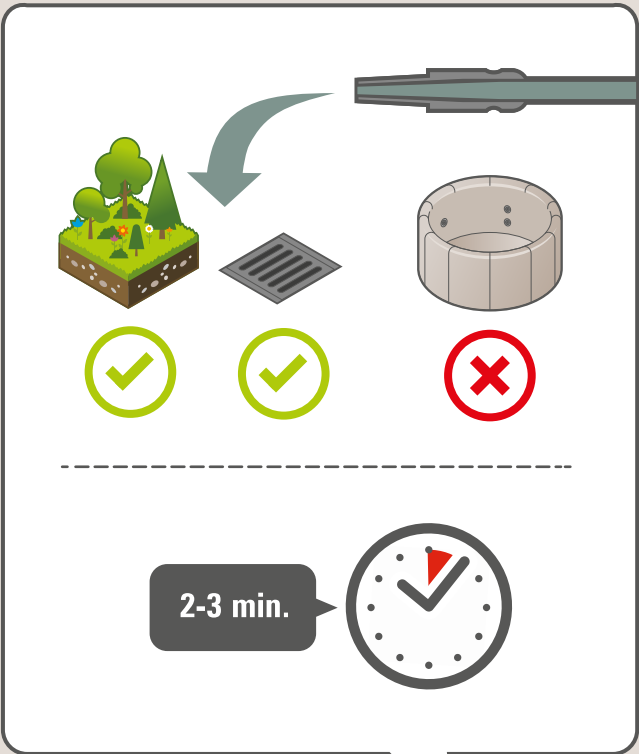

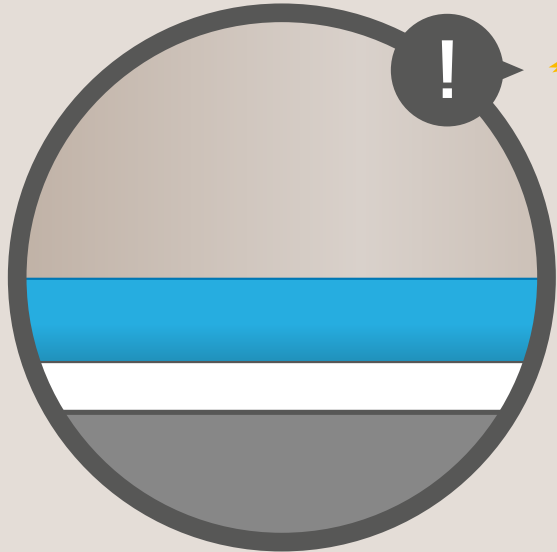



6

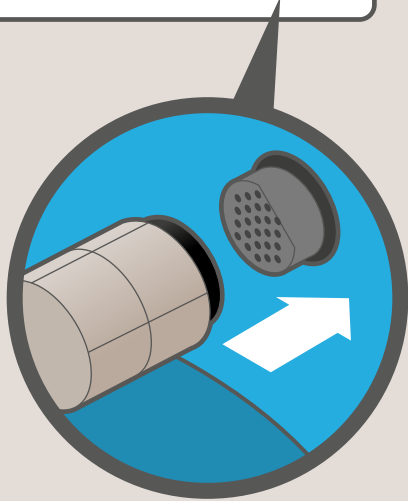
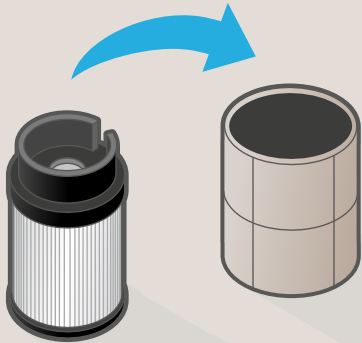
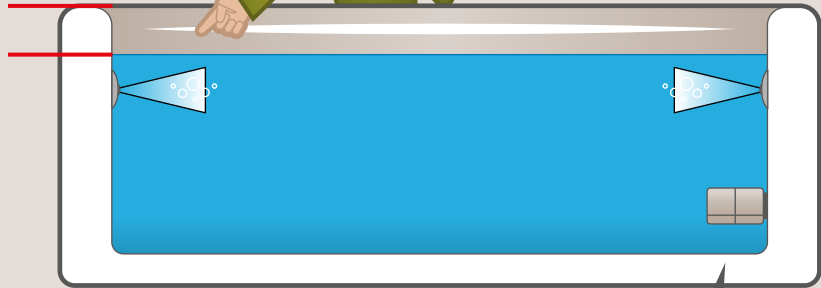
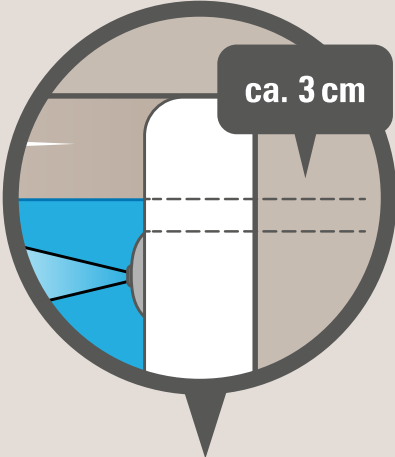
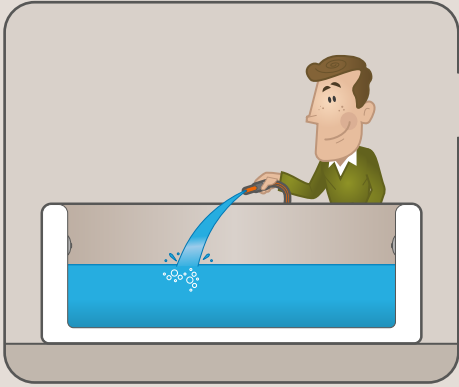

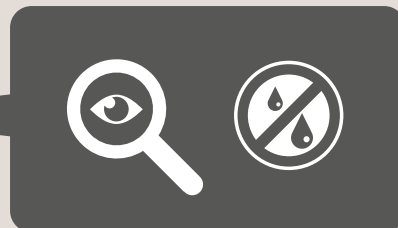
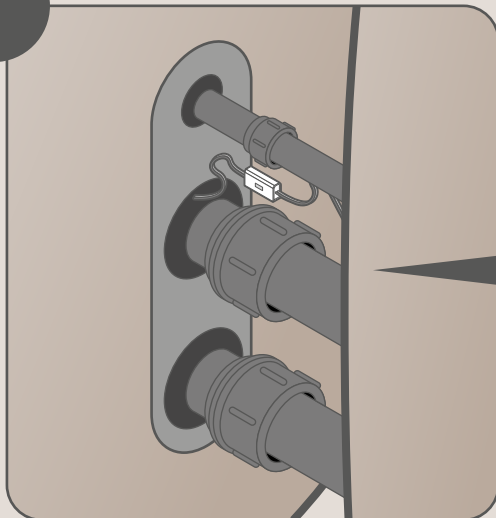

7



**1. STLAČIŤ**  
RESET

**2. STLAČIŤ**  
TEST

**3. STLAČIŤ**  
RESET

**4. TEST DOKONČENÝ**

UPOZORNENIE : Ak krok 2 nespustí motorovú jednotku, nechajte elektroinštaláciu skontrolovať odborným technikom.



